



## ULTRA DELPHI

### ALKALINE ANTIOXIDANT WATER

Experience the Power of Ionized Water from  
Emco Tech Ionizer NEW ULTRA DELPHI



#### DARC-Double Automatic Reverse Cleaning system

The electrodes are the crucial component in your ionizer. All other units on the market clean by a simple reverse polarity - which still allows some scale buildup. The Alphon MX offers the patented new DARC (Double Automatic Reverse Cleaning) system. This new system will completely eliminate the mineral scaling from on the electrodes ensuring you will have many long years of healthy water.

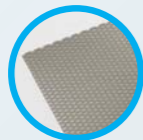

#### Electrolysis Platinum Titanium Mesh Electrode Plate

Mesh Platinum-coated Titanium electrodes with a proprietary matting enhances processing efficiency while at the same time provides extreme resistance to mineral deposits. It is specially designed to drain off all excess water in the electrolysis chamber. Alphon MX's electrodes are made of solid titanium, one of the toughest - yet human-friendly - metals known. This provides the electrodes with longevity built to last at least 20 years. The titanium is coated with platinum for excellent, yet durable, conductivity.



#### Advanced Computerized PCB

Hi-Tech Microcomputer (MICOM) system self diagnoses every function within the machine and can detect the pH and quality of any water source to ensure ionization is always optimal.



#### Flow Control Knob

This special feature has been, until now, only available on much more expensive ionizers. This enables you to control the flow of water easily on your ionizer which in turn affects the strength of the alkaline water and -ORP. The slower the water flow the more time the water has to be altered by the ionization process.



#### User-friendly Control Panel and Display

The controls have been designed with the Western kitchen in mind. The new control panel is membrane sealed making it easy to clean. A gentle touch on the buttons is all that is needed to change any setting.



#### Extra Calcium Port

This allows you to add extra calcium to your ionizer. Some areas however have "soft water" or water that is low in naturally occurring calcium and other dissolved minerals. This feature is intended to boost ionization performance in soft water areas when necessary.

# ULTRA DELPHI

## ALKALINE ANTIOXIDANT WATER

Experience the Power of Ionized Water from  
Emco Tech Ionizer NEW ULTRA DELPHI  
Convertible Undersink

From **ALKAVIVA**



## CONGRATULATIONS ON YOUR NEW PURCHASE!

You have just purchased the finest, most advanced water system in the world! Your new ionizer is designed to provide you with many years of the cleanest, healthiest and most "functional" water available. There are many specific uses and benefits of this amazing water, so read this manual carefully to learn how to get both optimum performance out of your ionizer and to protect your investment.

Your new Ultra Delphi produces filtered alkaline, ionized water. Just exactly what is that? The Ultra Delphi employs computer accurate and selectable magnetic energy to perform electrolysis through patented platinum bonded titanium electrodes inside a water cell. Inside this advanced cell, the magnetic energy separates the water into an alkaline (high pH) and acid (low pH) stream without using any chemicals. Ionizing the water in this way re-structures the molecules and reduces their cluster size, binds extra oxygen molecules, and concentrates ionized, absorbable and beneficial minerals like Calcium, Magnesium and Potassium.

Your new Ultra Delphi also produces Acidic water. This type water is low in pH, less than pH6 and has many excellent uses. You will now have the convenience and benefits of water that "functions" in many ways that ordinary tap, filtered or bottled water cannot.

# ULTRA DELPHI

## ALKALINE ANTIOXIDANT WATER

Experience the Power of Ionized Water from  
Emco Tech Ionizer NEW ULTRA DELPHI



- DARC cleaning system
- Stability and reliability power
- Exact calculation of filter durability
- Extended range of pH selection and control
- Electrolysis Platinum Titanium Mesh Electrode Plat
- Easy Filter Replacement
- Biostone Filter

## TABLE OF CONTENTS

Description	
Dear Customers .....	02-03
What is alkaline electrolyzed-reduced water? .....	04-05
Why the Ultra Delphi is the world's most advanced ionizer.....	06-07
Safety Precautions .....	
Power Related .....	08
Installation Precautions .....	09
During Usage .....	10
pH Reagent Liquid Precautions .....	11
Some helpful tips .....	11
How to Use .....	
Names and functions of Parts I .....	12-13
Names and functions of Parts II .....	14-15
Names and functions of Parts III .....	16-17
How to Install .....	18-23
How to Use .....	24-27
How to Measure pH .....	28
How to Use the Mineral port .....	29
How to Set your individual pH levels .....	29
How to Replace the Filter .....	30-31
About your Biostone Filter .....	32
Flow Diagram .....	33
Customer Service .....	
Trouble Shooting Guide .....	34-35
Specifications .....	36

## What is Ionized Water?

You can get Alkaline/Acidic electrolyzed-reduced water by electrolyzing the water after filtering impurities. Alkaline reduced water is the optimal water for health because it is rich in minerals including calcium. Acidic Water is good for skin.

### Some uses for the different levels of Alkaline Water



1

For initial consumption period (4-7 days). Let your body adjust slowly to the increase in pH. Many people find that this lower level is actually perfect for them.



2

After the adjustment period you can drink the water at this next level. This level is also great for cooking rice and other grains - fluffier and great tasting!



3

Some people like this for drinking though it can start to taste strong. It is superb for making tea or coffee as it enhances the taste and reduces bitterness!



4

Generally most people find this very strong tasting and with powerful detoxifying effects. Great for boiling vegetables! Alkaline water will eliminate the bitter taste and brings out more of their natural color.

### What would I use the Filtered Water for?



The pH of Filtered Water is neither raised nor lowered and would be the same as your tap water. This water is simply cleaned of impurities by the advanced filtration system. You can use it both as drinking water and to take medications with.

### Some uses for the different levels of Acidic Water

The Acid Water has both antiseptic and antibacterial properties. It also has an astringent effect and can be used for cosmetic purposes.



1

Use it while brushing your teeth, gargle with it and use it as a natural mouth wash!



2

It is an excellent astringent; use it for washing your face or as a natural after shave.



3

In the kitchen use it to help clean kitchen utensils.



4

This setting has sterilizing properties - use it to sterilize cutting boards, dish towels etc...

### Precautions for use of Alkaline water - don't develop a "drinking" problem!

- If you have never consumed Alkaline Water - do not use a setting higher than 1 to begin with.
- Let your body adjust slowly and naturally for 4-7 days. After this initial adjustment period, you can gradually increase the alkalinity of the water.
- Do not take medications with Alkaline Water. Take medications only with Filtered Water.
- Consult with a physician before drinking Alkaline Water if you have:
  - Chronic disease
  - A dysfunctional liver or intestines
  - Are currently under medical treatment
- Do not drink Alkaline Water if you have achlorhydria.
- Consult a physician before using Acidic Water if you have:
  - Sensitive skin
  - Allergies
- Only use potable drinking water in your ionizer.
- Poor water quality may have negative effects on your health and your ionizer! Most municipal water sources will be fine in your ionizer.
- Well water and water from smaller systems should be checked, and may require pre-filtering.
- Your ionizer is not under warranty for any damage or required cleaning caused by hard water deposits.

### Safety Precautions

Please read these pages carefully. They contain very important information to keep YOU and your new ionizer safe!



Warning

Property damage, serious injury or death may result if these instructions and precautions are not observed.



Caution

Physical injuries or material damage may be caused if the instructions are not observed.

### Do's and Dont's



DO NOT



Do not disassemble it.



Disconnect the power cord from the wall outlet.



DO



Do not touch it.



Ground product for protection from electric shock.

## What makes the Ultra Delphi Cutting-edge?



A revolutionary new automatic dynamic flow system employing patented SOL valves.

With the SOL valve system, your ionizer produces top quality alkaline water without the separate cleaning cycle of every other ionizer. The SOL valve system keeps desirable flow levels and pressure which prevents scale build up and protects from overloading the electrolysis cell. This feature also reduces the amount of flow from the Acidic drain line.



5-layered platinum-titanium electrodes

We use the most advanced platinum-titanium electrode plating process that consistently produces water with optimum ORP (Oxidation Reduction Potential) at the selected pH level.

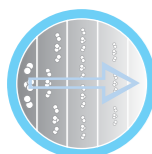

Triple diaphragms

Unique diaphragms made of natural pulp coated with PE and processed with surfactants keep pH, ORP and ion exchanges between acid and alkaline uniform despite changes in pressure, flow amount or velocity. They prevent scale buildup by employing a new material called fremion.



Mountain range-like specialized electrodes

When a cross section of an electrode is examined at 700 times magnification, you can see that the electrodes have very sharp points and form valleys. Your ionizer employs special electrodes that generate reduced water with optimal ORP and stable pH level.

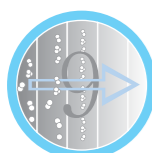

Top quality 9 step single-body nano-silver multi-stage filter

Premium filter materials ensure production of healthier and cleaner water, trapping a wide variety of contaminants while allowing beneficial minerals to pass through.

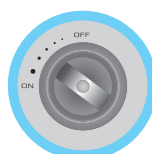

Flow Control Knob

This special feature has been, until now, only available on much more expensive ionizers. This enables you to control the flow of water easily on your ionizer which in turn affects the strength of the alkaline water and -ORP. The slower the water flow the more time the water has to be altered by the ionization process.

## Water selection and mode indicators



Your ionizer has an attractive colored FND display that easily identifies your selections.

Easy to understand symbols and colors identify the type and level of water you have selected on the machine.



Voice Indicator

A voice alerts you to your selection of alkaline, acidic or purified water. You can adjust the volume level or simply switch the sound ON/OFF as you desire.



9 settings for pH

Wide choice range of pH. Enhanced convenience with One-Touch operation



Digital Filter Life Indicator

The easy to read digital indicator gives you an approximate indication of remaining water filter life. Optimum performance is ensured by always changing your filter on time. In addition to the digital counter, a new indicator light will flicker when your current filter life is up, reminding you to change your filter.



Enhanced convenience in filter replacement

You remove the filter cover and the spring-loaded filter housing makes it a snap to replace your filter. **MAKE SURE NOT TO THROW AWAY THE GRAY FILTER CUP AT BOTTOM OF FILTER!!!**



MICOM control system

MICOM control system optimizes the pH and ORP of your water and helps keeps your ionizer in top working condition. A new indicator light alerts you if service is needed on your ionizer.



Flux control

Fully automated flux control through an advanced new patented valve system greatly enhances the optimization of pH and ORP in your water.



# Safety Precautions

If a break down occurs, do not make a repair by yourself. Contact the place of purchase or A/S center.

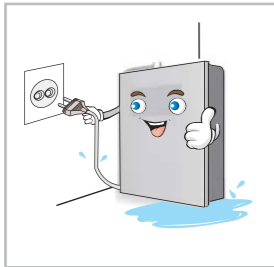

## ■ Electrical power precautions

- ⚠ If your ionizer becomes submerged in water, unplug the power cord from the wall BEFORE removing the ionizer from the water. Failure to do so may cause electric shock!
- ⚠ NEVER attempt to repair or service the unit yourself. Contact your dealer. Attempting to do so will void your valuable warranty!
- ⚠ Do not use your ionizer at voltages other than specified (AC 110V FOR USA). Use a GFI outlet. Do not plug in your ionizer where it will exceed the rating of outlet or electric wiring. Failure to do so can result in fire, injury and/or damage to yourself, wiring or ionizer!
- ⚠ NEVER touch the power cord or plug with wet hands - this may result in electric shock!
- ⚠ Ensure the power plug is firmly and properly inserted into the outlet - failure to do so may result in electric shock or fire!
- ⚠ Do not wash your ionizer by immersion or by pouring water over the main body; always unplug your ionizer while cleaning the casing. Clean with damp sponge or cloth.

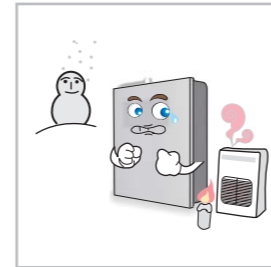
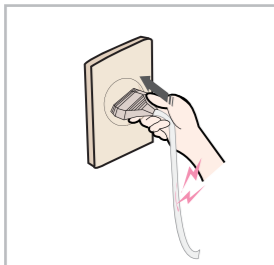
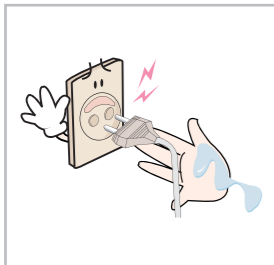
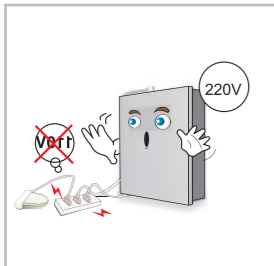

## ■ Installation Precautions

- ⚠ Protect your ionizer from freezing temperatures.
- ⚠ Protect your ionizer from direct sunlight.
- ⚠ Do not put anything heavy on top of your ionizer. Do not install your ionizer on an unstable or soft surface. Install only on a hard and level surface.

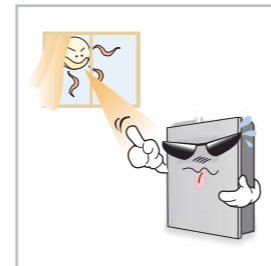

## ■ Maintenance Precautions

- ⚠ Always unplug your ionizer when changing the fuse or cleaning your ionizer - failure to do so may result in electric shock.

## ■ Common Sense Precautions

- ⚠ Do not attempt to repair or service the unit yourself. Contact your dealer. Attempting to do so will void your valuable warranty!
- ⚠ Make sure to use your ionizer only with potable water which is suitable for human consumption.
- ⚠ DO NOT use your ionizer with well water, water with extreme hardness, high sediment or TDS levels without first consulting your dealer.

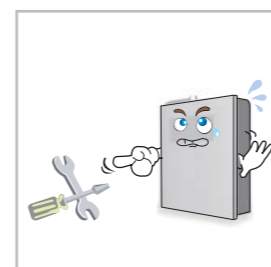

# Safety Precautions

If a break down occurs, do not make a repair by yourself. Contact the place of purchase or A/S center.

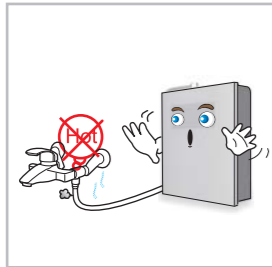

## ■ During Use

- ⚠ Do not run hot water through your ionizer.
- ⚠ Do not clean by pouring water over or spraying the ionizer.
- ⚠ Do not close, bend, pinch, press or otherwise obstruct output ports or hoses.
- ⚠ If the appliance makes strange or unusual noises or burning smells are detected, unplug the power cord immediately and contact your dealer to arrange service.
- ⚠ Unplug your ionizer if you plan not to use it for an extended period or turn off the main power switch on the back of the unit. Filter replacement may be necessary.
- ⚠ Unplug your ionizer if you plan not to use it for an extended period or turn off the main power switch on the back of the unit. Filter replacement may be necessary.

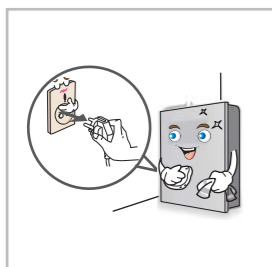
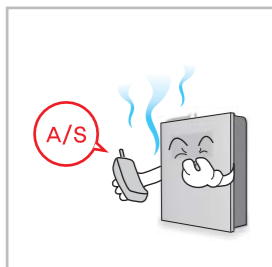
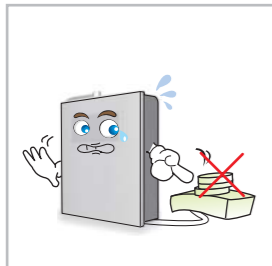
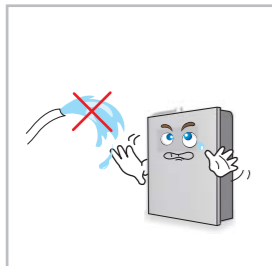

## ■ pH Reagent Liquid Precautions

- ⚠ Do not expose the pH measuring reagent to extreme heat, flames or fire. It is combustible.
- ⚠ Do not drink the pH reagent liquid, put it in the eyes or apply to the body.
  - If the liquid is ingested, induce vomiting immediately and call a doctor.
  - If the liquid gets in the eyes, flush immediately and thoroughly with cool water; call a doctor.
  - If spilled or dropped on your body, wash it off immediately.
- ⚠ Make sure to keep the pH reagent liquid tightly closed and out of the reach of children.



## ■ Some helpful tips

- ⚠ For storing your alkaline water, glass or ceramic is best. Always try and keep your stored water cool and away from direct sunlight. You can use plastic, but only use lexan (number7) or poly bottles (Nalge type). It is always best fresh out of the machine and ideal if consumed on a day-today basis.
- ⚠ Do not store alkaline water in stainless steel, bronze or aluminum containers.
- ⚠ Save the box and Styrofoam your ionizer came packed in. This will help if your ionizer needs to be transported at a later date.
- ⚠ Do not use an ionizer downstream of a sodium-based ion exchange softening system or Reverse Osmosis system without first consulting with your dealer.



# Names and functions of Parts I

ULTRA DELPHI



## ■ Front

- 1 Body (Front Panel)
- 2 Function display panel
- 3 Function Button
- 4 Flexible stainless steel Alkaline water outlet.
- 5 Knob (Water supply Valve)

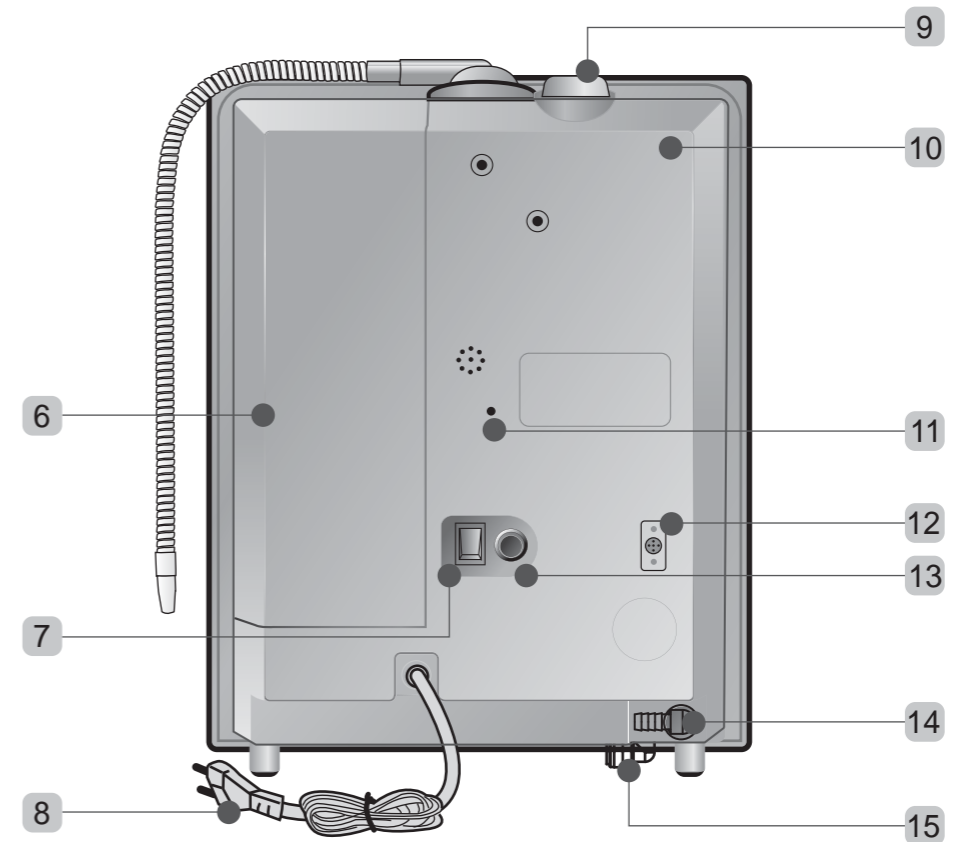

## ■ Back

- 6 Filter cover
- 7 Main switch
- 8 AC Power cord
- 9 Calcium cap
- 10 Rear cover
- 11 Volume controller
- 12 Connect Port
- 13 Fuse holder
- 14 Acidic water outlet port
- 15 Tap water inlet

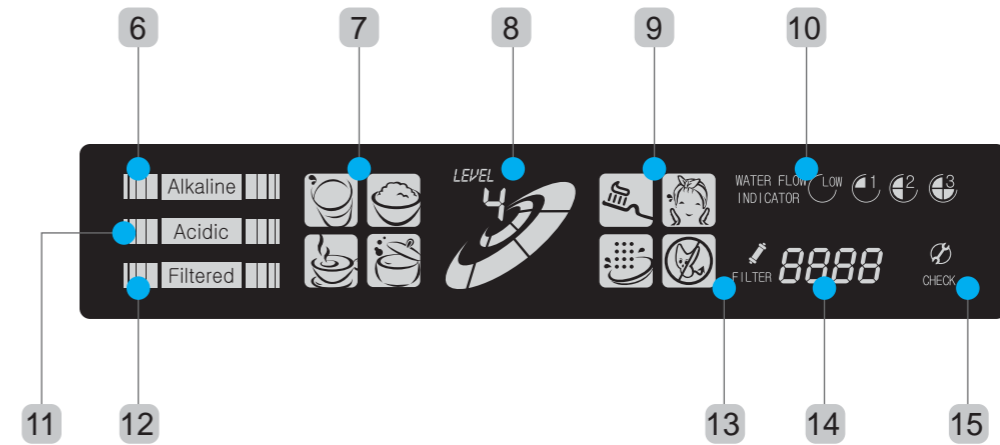
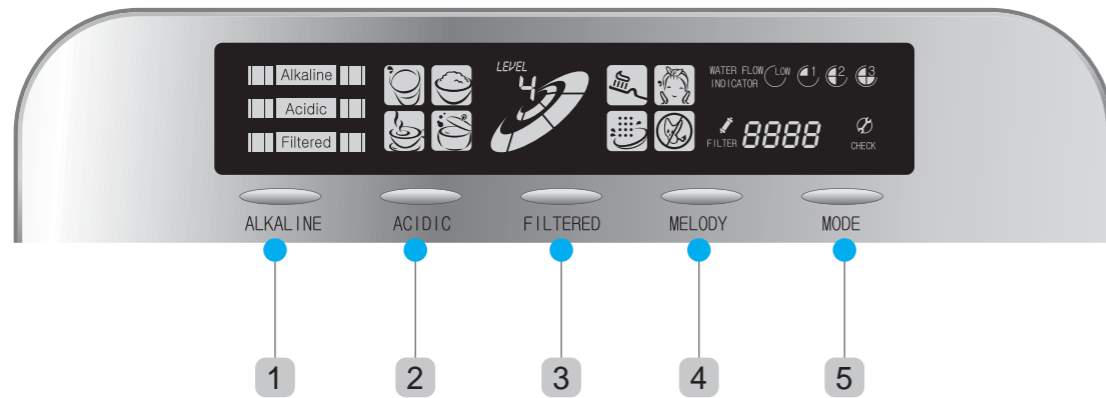

## Function Buttons

- 1 "ALKALINE" Water Button  
Used to select Alkaline water and the desired level (1-4)
- 2 "ACIDIC" Water Button  
Used to select Acidic water and the desired level (1-4)
- 3 "FILTERED" Water Button  
Used to select Filtered water.
- 4 "MELODY" Button  
Turns the sounds On or Off. Additionally, the volume can be adjusted on the back.
- 5 "MODE" Button  
Used to select Topsink or Under sink mode.

## Indicators

- 6 Alkaline Water display indicator  
The blue indicator will light when alkaline water is selected.
- 7 Alkaline pH level indicator  
A blue symbol shows which level of Alkaline Water is selected.
- 8 pH level indicator  
When Alkaline Water is selected a blue number (1-4) will indicate which level.  
When Acid Water is selected an orange number (1-4) will indicate which level.
- 9 Acidic level indicator  
An orange symbol shows which level of Alkaline Water is selected.
- 10 Flux indicator  
Indicates the water flow in your ionizer.
- 11 Acidic Water display indicator  
The orange indicator will light when Acidic Water is selected.
- 12 Filtered Water display indicator  
The green indicator will light when Filtered Water is selected.
- 13 Filter replacement indicator  
Flickers when the filter needs replacing.
- 14 Filter life indicator  
Counts filter usage in a digital display.
- 15 Caution light  
When this light is lit the appliance needs to be serviced.



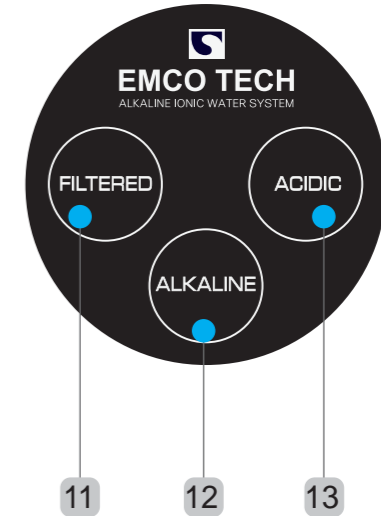
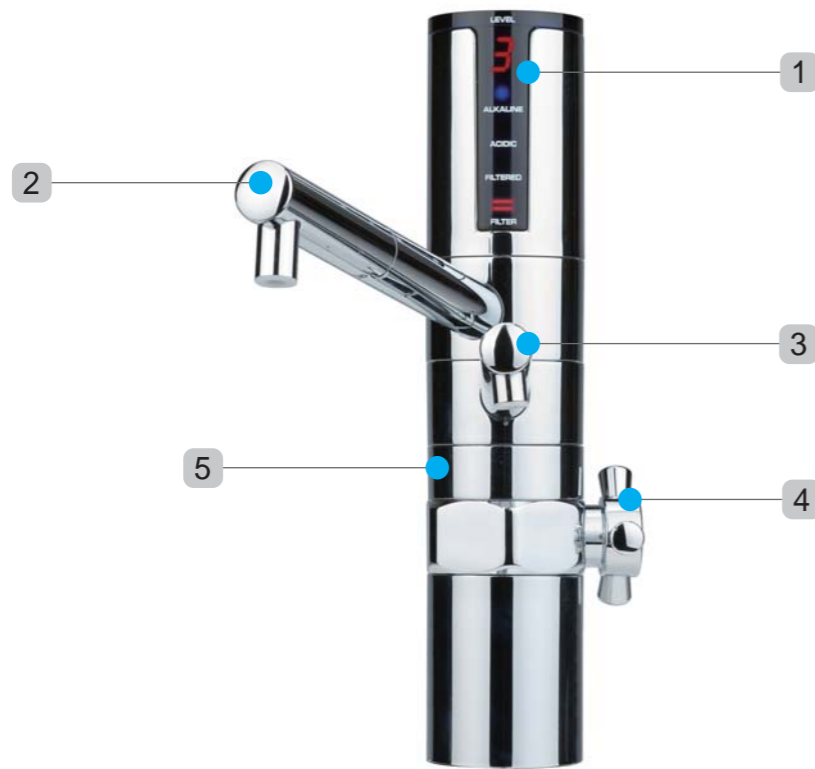

## ■ Faucet

- 1 Function display panel
- 2 Primary Water Outlet
- 3 Secondary Water Outlet
- 4 Faucet Control Lever
- 5 Body

## ■ Indicators

- 6 pH level indicator  
This numeric display will indicate the level of Alkaline or Acidic Water selected. If filtered water is selected, the display will show 0.
- 7 Alkaline Water display indicator  
If Alkaline Water is selected the BLUE indicator will be lit.
- 8 Acidic Water display indicator  
If Acidic Water is selected the ORANGE indicator will be lit.
- 9 Filtered Water display indicator  
If Filtered Water is selected the GREEN indicator will be lit.
- 10 Filter life indicator  
Displays the current filter life used. When the scale reaches the top and flickers, it is time to replace your filter.
- 11 FILTERED Water button  
Used to select Filtered Water
- 12 ALKALINE Water button  
Used to select Alkaline Water and the desired level (1~4)
- 13 ACIDIC Water button  
Used to select Acidic Water and the desired level(1~4)

# Accessories

# How to install your Ultra Delphi ULTRA DELPHI

**⚠ WARNING :** Incorrect installation could void your valuable warranty - professional installation is recommended.

## ■ Ionizer Accessories

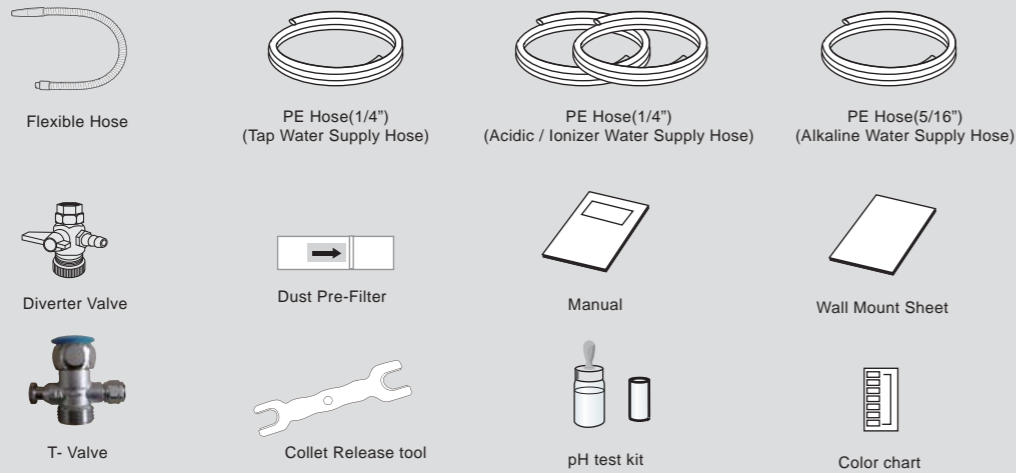

## ■ Faucet Accessories

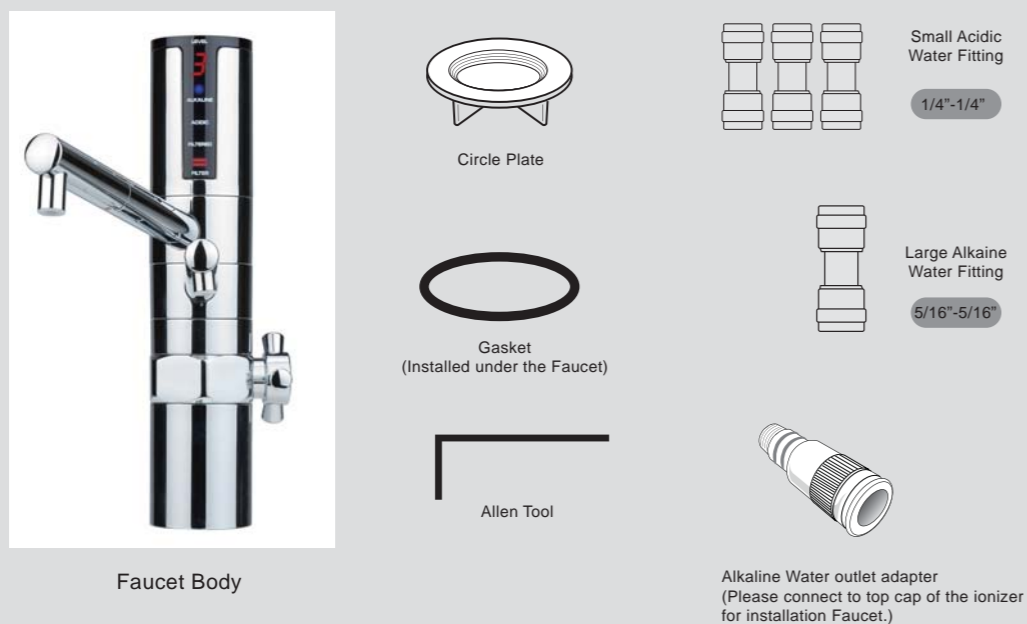

## ■ Installation Method

Method 1 : Under the sink with Faucet

All the fittings are push in style fittings. To attach the hoses to any fitting firmly insert the end of the hose into the fitting. Pull firmly to check to connection - you should not be able to pull the hose out. To release the hose from the fitting, use the provide collet release tool to depress the spring loaded ring protruding from the end of the fitting while pulling the hose out. [Online videos are available showing the use of quick-connect fittings.]

- 1 Use appropriate tools to make 1.5"(30mm) diameter hole in the location where you will install the faucet. Make sure the faucet location will allow both spout to reach the sink.(Fig.1)
- 2 Unscrew circle plate from faucet body.
- 3 Place the faucet in the hole ensuring the gasket comes between the faucet and your counter/sink top. (Fig.2)
- 4 Thread the circle plate on to the faucet body under the sink secure the faucet. (Fig.3)
- 5 Connect the 1/4" small Acidic and Water fittings and 5/16" large Alkaline Water fitting to the corresponding faucet hoses. (Fig.4)

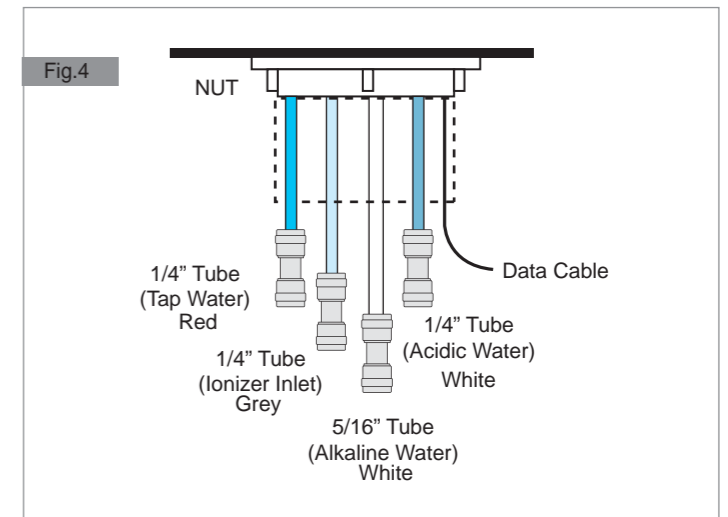
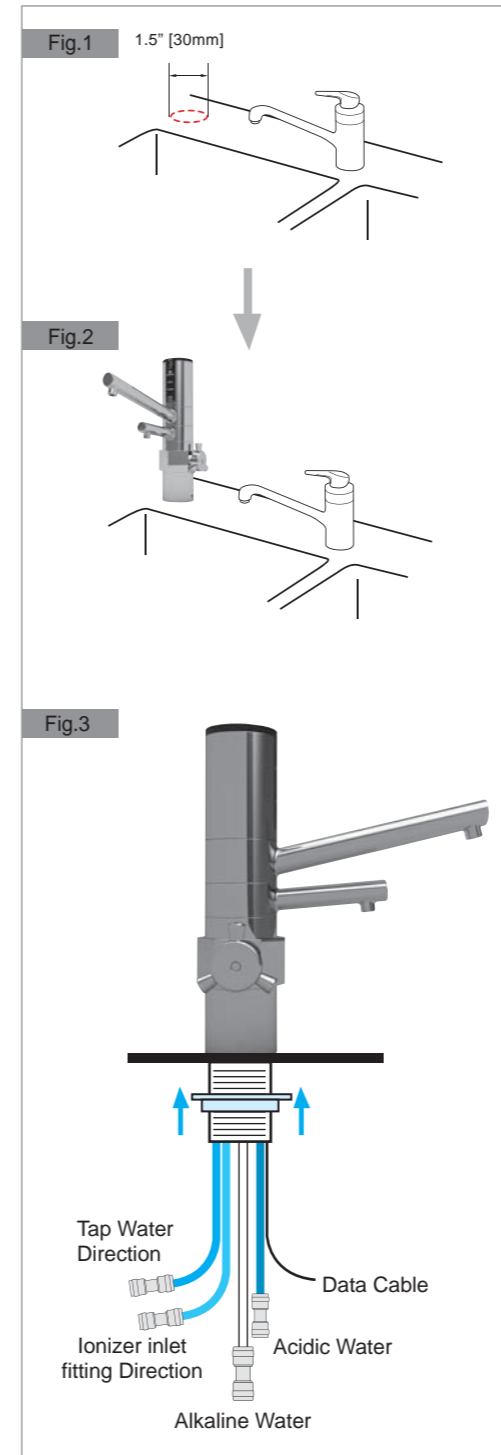

# How to install your Ultra Delphi

ULTRA DELPHI

**⚠ WARNING :** Incorrect installation could void your valuable warranty - professional installation is recommended.

All the fittings are push in style fittings. To attach the hoses to any fitting firmly insert the end of the hose into the fitting. Pull firmly to check to connection - you should not be able to pull the hose out. To release the hose from the fitting, use the provide collet release tool to depress the spring loaded ring protruding from the end of the fitting while pulling the hose out. [Online videos are available showing the use of quick-connect fittings.]

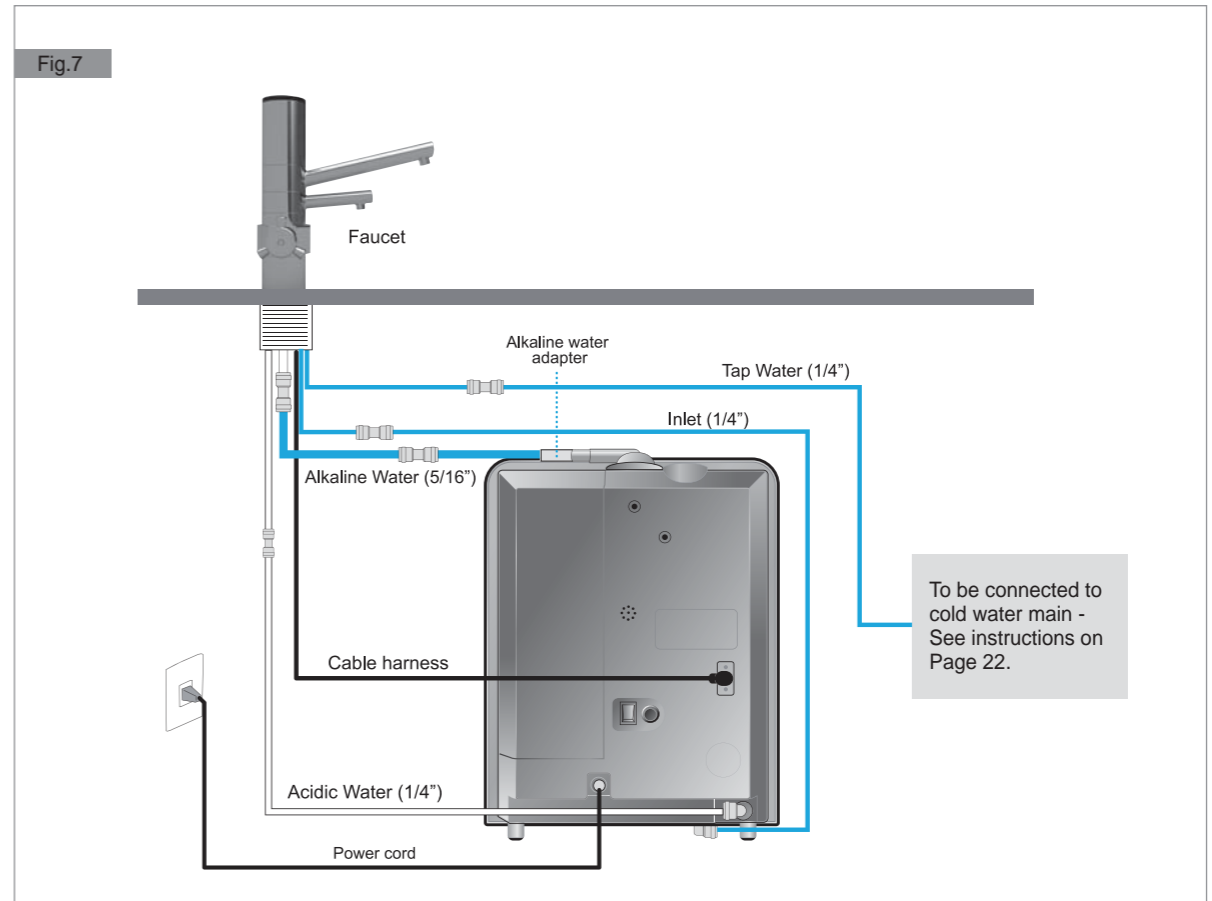
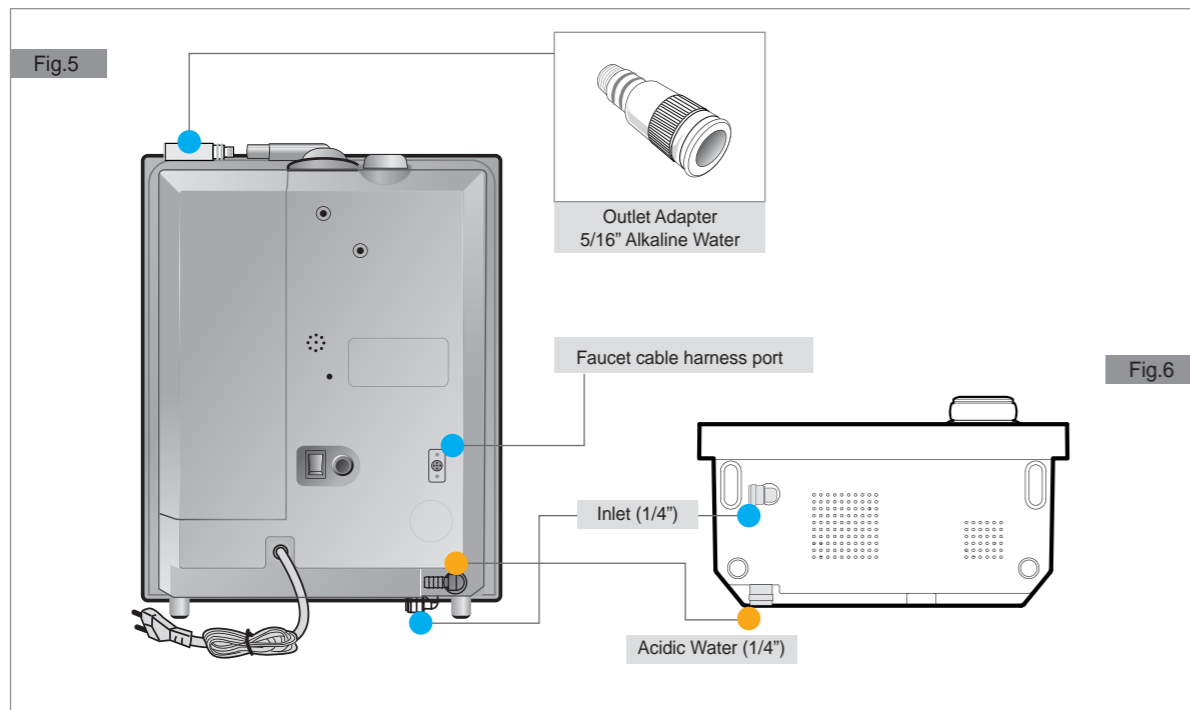

## ■ Connecting Ionizing Unit to Faucet

- 1 Connect 5/16" Alkaline Water outlet adapter to top cap of the ionizer (Fig.5)
- 2 Remove the plugs at Inlet and Acidic Water ports located on the bottom of your ionizer unit using the provided collett release tool. (Fig 6)
- 3 At this time, check the filter installation to make sure it has not loosened during shipping. (Information on filter installation is found on page 30)

## ■ Connecting Ionizing Unit to Faucet

- 4 Clean out the area under your sink and place the Ultra Delphi ionizer in an appropriate location.
- 5 Connect the 1/4" WHITE Acidic Water Hose, Tap Water Supply Hose and Ionizer Inlet hose to the small fittings attached to the corresponding faucet hoses which are identified in Fig.7 above. Pull firmly to check to connection - you should not be able to pull the hose out.
- 6 Connect 5/16"Alkaline Water Hose to the large fitting attached to the corresponding faucet hose identified in Fig.7 above. Pull firmly to check to connection you should not be able to pull the hose out.
- 7 Connect all hoses to the ionizer as indicated in Fig.7. 1/4" tap water supply hose will be connected to cold water main - instructions on Page 22.
- 8 Plug the cable harness into the Cable Harness Port on the back of the ionizer.
- 9 Connect the power cord into an appropriate outlet. Make sure the outlet you plug your ionizer into is live, and remember that many outlets under the sink are controlled by an on/off switch.

# How to install your Ultra Delphi

ULTRA DELPHI

## Connecting ionizing Unit to Cold Water Line

Method 2 : Countertop Direct Plumbing

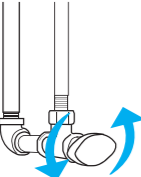
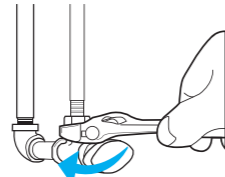
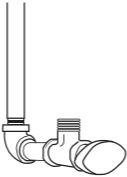
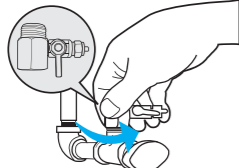
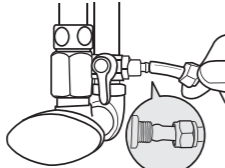
<p>1</p> 	<p>2</p> 	<p>3</p> 
<p>Find the cold water supply line and close the valve.</p>	<p>Disconnect the cold water hose from the line. Make sure it is the cold water hose and not hot because hot water will cause the unit to malfunction.</p>	<p>Separate the water line.</p>
<p>4</p> 	<p>5</p> 	<p>6</p>
<p>Connect the cold water line adapter to the cold water supply valve as shown. As fittings vary you will need to find the right size adaptors at your local plumbing store.</p>	<p>Connect the plastic tubing as shown.</p>	<p>See below for instructions on connecting the inlet and outlet hoses.</p>

## Installing the Inlet and Outlet Hoses for Countertop Use (Method 2 and 3)

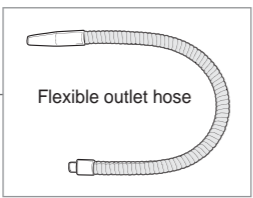

Fig.8

To connect water inlet hose, first remove the 1/4" plug from the cold water inlet fitting by sliding the collett release tool between the plug and the white collett to release the plug. With the collett tool in this position, the plug can be pulled out of the cold water inlet fitting. With the plug removed, simply press the 1/4" white water inlet tube in to the water inlet fitting making sure to press firmly to ensure a proper seal. (Fig.8)

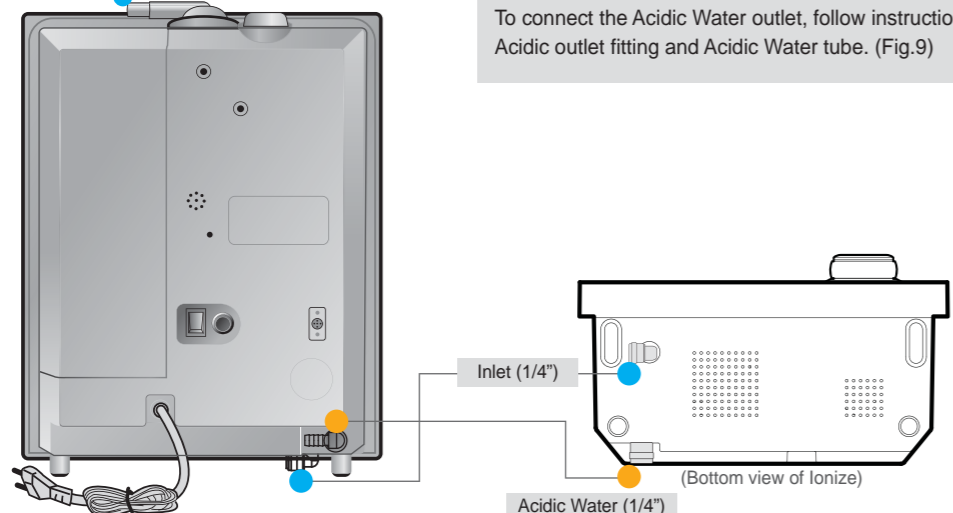

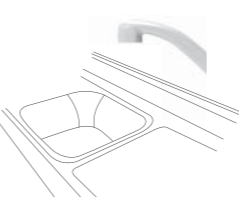

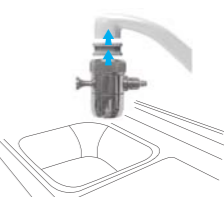



Fig.9

To connect the Acidic Water outlet, follow instructions above using the Acidic outlet fitting and Acidic Water tube. (Fig.9)

Labels in Fig.9: Inlet (1/4"), Acidic Water (1/4"), Acidic Water (1/4") White.

## Connecting ionizing Unit to Faucet

Method 3 : Countertop Connect to Faucet

<p>1</p> 	<p>2</p> 	<p>3</p> 
<p>Place the water ionizer near the sink where the ionizer will be installed.</p>	<p>Remove the aerator from the faucet</p>	<p>Attach the diverter valve to the faucet using any included adapter rings necessary. Be sure to clean any exposed threads and apply plumber's tape to prevent leaks. If installing to a pull-out/spray style faucet, please contact your dealer for information on a specialty adapter that may be required.</p>
<p>4</p> 	<p>5</p> 	 <p>Optional Diverter</p>
<p>Remove the compression nut from the diverter valve and thread the plastic supply tubing through it, making sure to keep the threads of the compression nut facing the diverter valve.</p>	<p>Attach the plastic supply tubing to the diverter valve by pressing it onto the compression nipple and securing the compression nut to the diverter valve.</p>	

### CAUTION

- Be sure the valves are all connected tightly to prevent leakage.
- Be sure of where you want to install the ionizer as you will need to drill a hole through the sink top in order to thread the tube.
- Be sure you connect the unit to cold water line. Hot water can damage the unit.
- This is a good time to double check and make sure all your fittings are tight and the tubing is secure in the fittings.
- Check daily for any leaks during the first week after the installation and check for leaks occasionally there after.

## Overview of Hose Connections (Method 2 and 3)

Fig.10

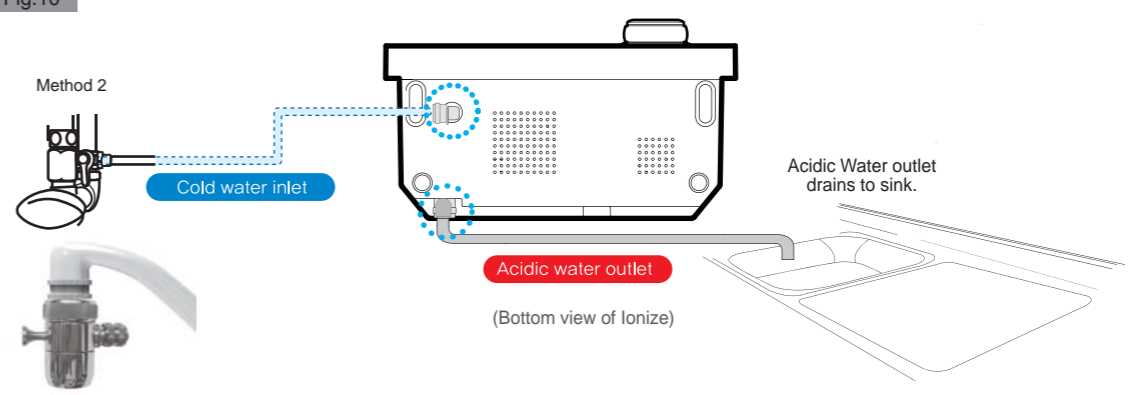

Method 2: Cold water inlet

Method 3: Acidic water outlet

(Bottom view of Ionize)

Acidic Water outlet drains to sink.

- **IMPORTANT!** Complete all steps of installation method 1.(P 19) Make sure the main power switch is in the OFF position on the back of the unit, and the unit is plugged into an electrical outlet.

Fig.11



Fig.12

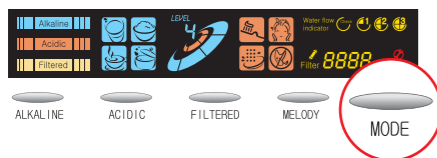

Fig.13

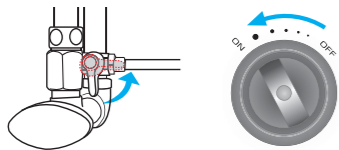
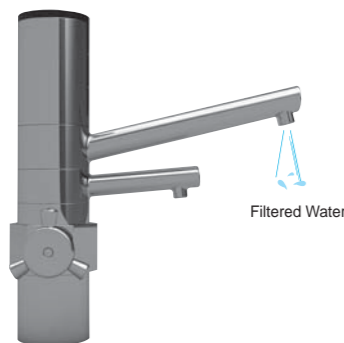
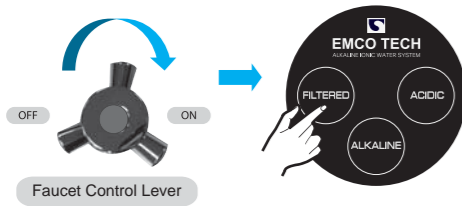

Fig.14



### Initial operation

- 1 Turn the power button to the "ON" position on the back of the ionizer. (Fig.11)  
- The power button is ALWAYS left on.
- 2 Press the MODE button once. (Front panel of ionizer) (Fig.12)
- 3 Turn on the water  
Turn on the water by opening the water supply valve under the sink. Turn flow control knob on front of ionizer to ON position. These will always remain in the ON or OPEN position.(Fig.13)

### To Select Filtered Water (Fig.14)

- 1 Start water flow through your ionizer  
- Turn on the "Lever" on the side of your faucet to start the water flow.
- **NOTE**  
The water may initially come out discolored(light to charcoal grey) due to carbon particulate in the new filter. This is not harmful and is typical of all carbon filters. Allow the water to flow for 2-3 minutes in the "Filtered" mode and this will flush all the carbon dust.
- 2 With the water running through your faucet, press the "FILTERED" button.  
The display panel will show a green symbol.  
The Filtered water will come out of the top spout.

### How to shut off the water flow from your ionizer

With the water running through your faucet, turn the lever to the OFF position.  
The water will stop and the display panel will go dark indicating the ionizer is in standby mode.

- **NOTE**  
Your ionizer will always "remember" the last setting used. If the previous selection was Alkaline level 2, when you start flow through the ionizer next time you use the ionizer it will automatically preces at Alkaline level 2.

Fig.15

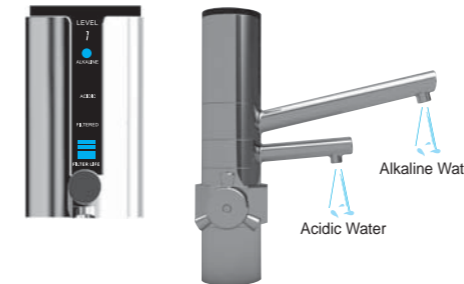
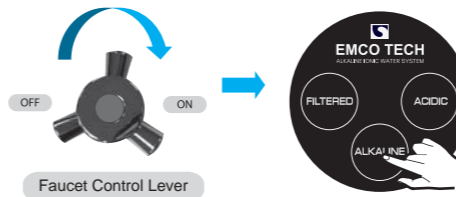
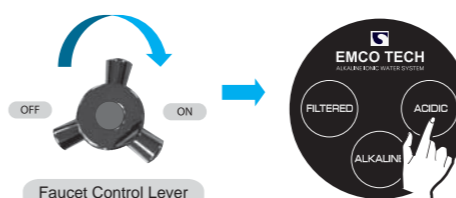

Fig.16



### To select Alkaine Water (Fig.15)

- 1 **START WATER FLOW THROUGH YOUR IONIZER**  
Depress the "ALKALINE" button to select the desired setting from 1-4.  
The Alkaline Water will come out from the top spout.  
The display panel on the front of the faucet will show a blue Alkaline indicator and a number corresponding to the level selected.
- 2 **TO CHANGE LEVELS OF ALKALINE WATER**  
To select a different level, depress the "ALKALILNE" button to move to next level until the desired setting level is achieved.  
The number will change accordingly.

### To select Acidic Water (Fig.16)

**NOTE : Acidic Water is for external use only. DO NOT DRINK.**

- 1 **START WATER FLOW THROUGH YOUR IONIZER.**  
Depress the "ACIDIC" button to select the desired from 1-4.  
The Acidic Water will come out from the top spout.  
The display panel on the front of the faucet will show a red Acidic indicator and a number corresponding to the level selected.
- 2 **TO CHANGE LEVELS OF ACIDIC WATER**  
To select a different level, depress the "ACIDIC" button to move to next level until the desired setting level is achieved.  
The number will change accordingly



- **IMPORTANT!** Complete all steps of installation method 2 and 3(P 22-23) Make sure the main power switch is in the OFF position on the back of the unit, and the unit is plugged into an electrical outlet.

Fig.17



Fig.18

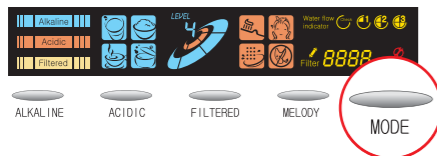

Fig.19

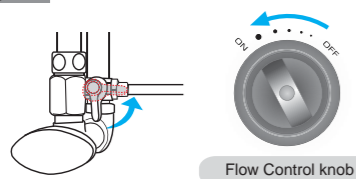
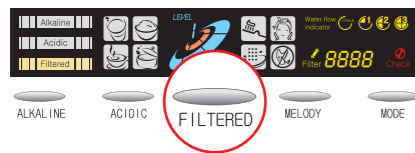

Fig.20



### Initial operation

- 1 Turn the power button to the "ON" position on the back of the ionizer. (Fig.17)  
- The power button is ALWAYS left on.
- 2 Press the MODE button once. (Front panel of ionizer) (Fig.18)
- 3 Turn on the water  
Turn on the water by opening the water supply valve under the sink.  
Turn flow control knob on front of ionizer to ON position.  
These will always remain in the ON or OPEN position.(Fig.19)

### To Select Filtered Water (Fig.20)

- 1 Start water flow through your ionizer  
- Turn flow control knob to the ON position (Front of ionizer)
- **NOTE**  
The water may initially come out discolored(light to charcoal grey) due to carbon particulate in the new filter. This is not harmful and is typical of all carbon filters. Allow the water to flow for 2-3 minutes in the "Filtered" mode and this will flush all the carbon dust.
- 2 With the water running through your ionizer, press the "FILTERED" button.  
The display panel will show a green symbol.  
The Filtered water will come out of the top spout.

### How to shut off the water flow from your ionizer

- Installation Method #2  
At the sink under direct main pressure  
: Turn the flow control valve to the "OFF" position.
  - Installation Method #3  
At the sink with a diverter  
: Turn off the water at your faucet.
- The water will stop and the display panel will go dark indicating the ionizer is in standby mode.

Fig.21

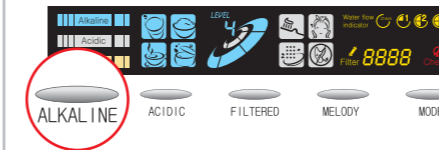
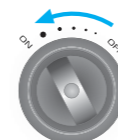

Fig.22



### To select Alkaine Water (Fig.21)

- 1 **START WATER FLOW THROUGH YOUR IONIZER**  
Depress the "ALKALINE" button to select the desired setting from 1-4.  
The Alkaline Water will come out from the top spout.  
The display panel on the front of the faucet will show a blue Alkaline indicator and a number corresponding to the level selected.
- 2 **TO CHANGE LEVELS OF ALKALINE WATER**  
To select a different level, depress the "ALKALILNE" button to move to next level until the desired setting level is achieved.  
The number will change accordingly.

- **NOTE**  
Your ionizer will always "remember" the last setting used.  
If the previous selection was Alkaline level 2, when you start flow through the ionizer next tiem you use the ionizer it will automatically preces at Alkaline level 2.

### To select Acidic Water (Fig.22)

**NOTE : Acidic Water is for external use only. DO NOT DRINK.**

- 1 **START WATER FLOW THROUGH YOUR IONIZER.**  
Depress the "ACIDIC" button to select the desired from 1-4.  
The Acidic Water will come out from the top spout.  
The display panel on the front of the faucet will show a red Acidic indicator and a number corresponding to the level selected.
- 2 **TO CHANGE LEVELS OF ACIDIC WATER**  
To select a different level, depress the "ACIDIC" button to move to next level until the desired setting level is achieved.  
The number will change accordingly

- **NOTE**  
Your ionizer will always "remember" the last setting used.  
If the previous selection was Acidic level 2, when you start flow through the ionizer next tiem you use the ionizer it will automatically preces at Acidic level 2.

Fig.23



## ■ How to Mute the sound (Fig.23)

- 1 With water running through the ionizer, press the "MELODY" button. All sounds except for the chime sounds will be muted.
- 2 You can adjust the volume with a small Phillips screw driver by manipulating the Speaker Volume on the back of your ionizer.

Fig.24

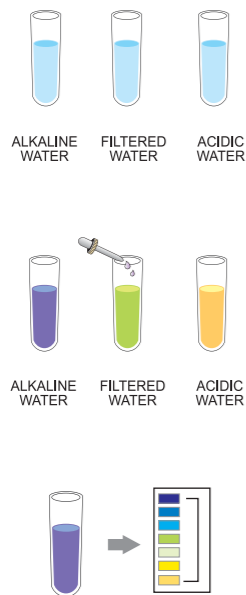

## ■ How to Measure pH (Fig.24)

• Important Note: Water quality and mineral content vary greatly in different localities and will directly impact performance of your ionizer with respect to pH.

- 1 Fill one of the test tubes provided about 1/4 full with alkaline, acidic or purified water.
- 2 Drop 2 or 3 drops of the pH reagent into the container and shake it.  
If the reagent and water are not mixed well, the correct result may not be displayed.
- 3 The pH value is determined by matching the color the pH color chart provided.

## ⚠ Caution

- DO NOT consume water containing reagent.
- Keep the pH reagent liquid, color chart, and test tubes away from direct sunlight.
- KEEP pH reagent liquid AWAY FROM CHILDREN and OPEN FLAMES!
- For contact with eyes, flush liberally with fresh water, seek medical help
- If ingested, induce vomiting, seek medical help.

## ■ Regularly check and clean your Pre-Filter

- Keeping the pre-filter clean is critical to the proper operation of your ionizer.
- First ensure your water supply is turned off.
- Then remove the pre-filter by pressing on the end of the fitting and pulling out the hose at the same time. Rinse out the filter thoroughly to remove any built up particulate.
- Rinse from both sides.
- Reinstall it.
- Clean the filter in this way any time you notice a decreased flow from your ionizer.

Fig.25

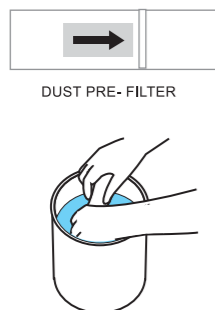

Fig.26

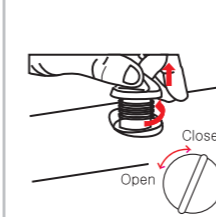

Fig.27

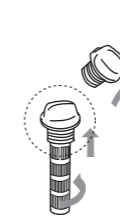

Fig.28

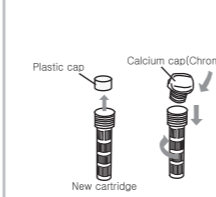
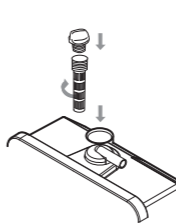

Fig.29



## ■ How to use the mineral port

There is a port at the top of your ionizer that is used for water conditioning agents, i.e. the manufacture-supplied calcium or other hard water conditioning agents.

- 1 Stop the water flow prior to calcium replacement.  
- Water will overflow if you open the calcium cap while water is coming out.
- 2 Unscrew the cap to the left and remove.  
-The first time you remove it the cap may be tight. Use a butter knife to work it free.
- 3 Take the basket apart from the cap and dispose of the remaining beads. The beads never completely disappear - it's the calcium coating on the beads that slowly releases into the water.  
Beads will release calcium for about 1-2 months depending on amount of use and pH of water.
- 4 Add the new calcium beads and close the cap.
- 5 Insert the basket into the calcium port and twist the cap closed.  
- Water will overflow if you do not close the cap tightly.

Fig.30

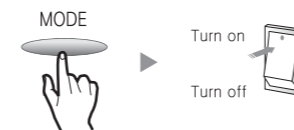

## ■ How to set your individual pH levels

- 1 Turn on the main switch on the rear case while pressing the MODE BUTTON on the front. (Fig.30)
- 2 With the beep sound, the default setting level 3 appears on the pH level indicator of the display panel. (Fig.31) (You can select the desired setting from 0-6)
- 3 Depress the "ALKALINE" button to raise to the desired setting, and depress the "ACIDIC" button to lower to the desired setting. (Fig.32)
- 4 To fix the setting you selected, depress the MODE button on the front. (Fig.33)

Fig.31



Fig.33



Fig.32

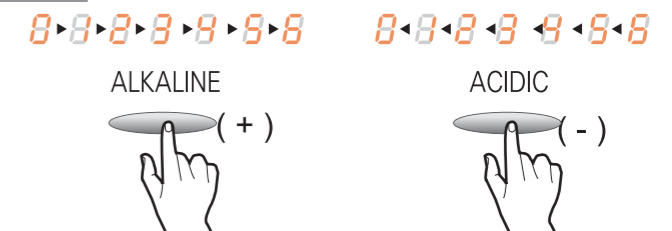

**!** IMPORTANT! Stop water flow prior to filter replacement.

Fig.33



Fig.34



Fig.35

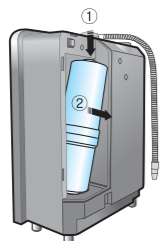

Fig.36

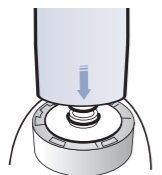
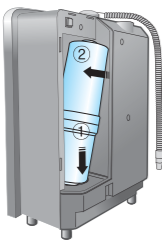

Fig.37



## How to Replace the Filter

- 1 When the digital filter life indicator reaches full or you see the flickering filter symbol, it is time to replace your filter. (Fig.33)
- 2 Open the filter housing cover. (Fig.34)
  - First, slide the cover upwards. Then, slide the cover to the left and remove it.
- 3 Remove the expired filter. (Fig.35)
  - Taking hold of the filter securely with your right hand, press the filter firmly down against the spring loaded mechanism to disengage the top of the filter and then pull it toward you and up to remove it.
  - The upper part of the filter is separated from housing by pressing firmly down. Once you have engaged the spring loaded mechanism, you can then easily remove the filter from the main body by pulling it toward you.
- 4 Insert the new filter into the compartment. (Fig.36, 37)
  - Seat the large opening on the bottom of the filter cartridge onto the base in the center of the filter cushion.
  - Push the filter down and into the housing compartment ensuring the opening at the top of the filter is seated properly into the fitting at the top of the housing.
  - Spin the filter to ensure a good seal on the O-rings.

**!** Check for leakage by running water through your ionizer before replacing the housing cover.

Fig.38

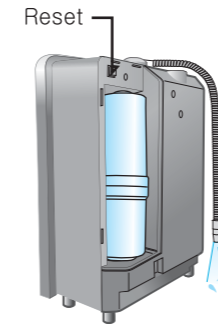

Fig.39

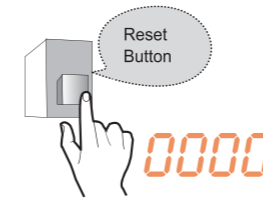

Fig.40



## How to Replace the filter

- 5 Flush out the GAC carbon dust. (Fig.38)
  - The water will initially come out discolored (light to charcoal gray) due to carbon particulates in the new filter.
  - This is not harmful and is typical of all GAC filters.
  - Allow the water to flow for 2-3 minutes in the "Filtered" mode and this will flush all the carbon dust.
  - Immediately after filter replacement, the water will come out black and unclear due to the activated carbon particulates in the new filter but will become clear momentarily. (It is not harmful.)
- 6 Reset the filter life indicator. (Fig.39)
  - Press the "Reset" button located at the top of the filter housing compartment for 2-3 seconds while in standby mode (water not running through the ionizer).
- 7 Replace the filter housing cover. (Fig.40)

**!** Please replace filter when any one of the flowing occur:

- Please replace filter when any one of the flowing occur:
- When severely polluted water has been run through the ionizer and filter.
- Excessive odor in output water and/or severely decreased flow rate.
- After prolonged period of inactivity of over 30 days.

# About your Biostone Filter

## Emco Tech's revolutionary BioStone Filtration System

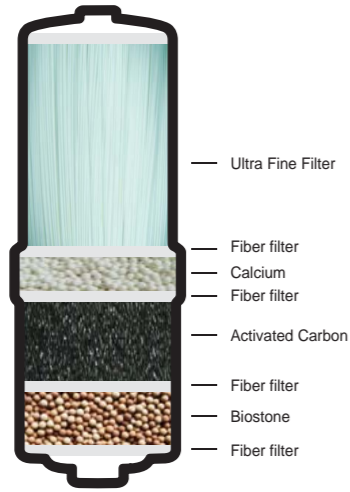

High Performance UF Filter

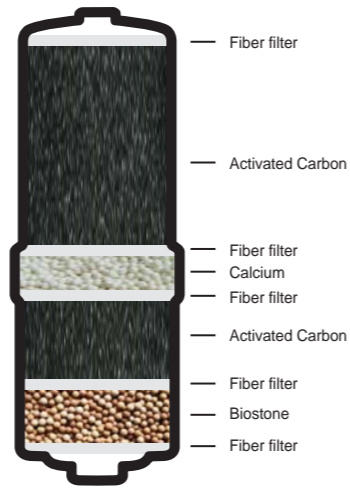

High Performance Carbon Filter

### Composition of filter

- 1 Calcium**  
It slightly increases the alkaline mineral content in your water. It improves water taste and odors, and it is particularly effective in removing the chloride. You get calcium on tap!
- 2 Tourmaline (Biostone)**  
Tourmaline emits Far Infra Red (FIR) energy naturally. FIR produces well documented health benefits and it also has an amazing effect on water. The Biostone contains the semi -precious gemstone tourmaline in ceramic form, so you get FIR on tap!
- 3 Granular Activated Carbon (GAC)**  
The workhorse of the filtration media. GAC is especially effective at removing chlorine, its odor and taste, agricultural chemicals, phenol, trihalomethane and other chemical contaminants. Silver is coated on the surface of the granular activated carbon to inhibit bacterial growth in between use.
- 4 Non woven fabric filter**  
Filters out sediment and particulate.
- 5 UF(Ultra Fine) Filter**  
Hollow heavy duty fiber with pores that will effectively filter down to 0.01M in size, removing bacteria and other micro-organisms.

# Flow Diagram

ULTRA DELPHI

## Flow Diagram

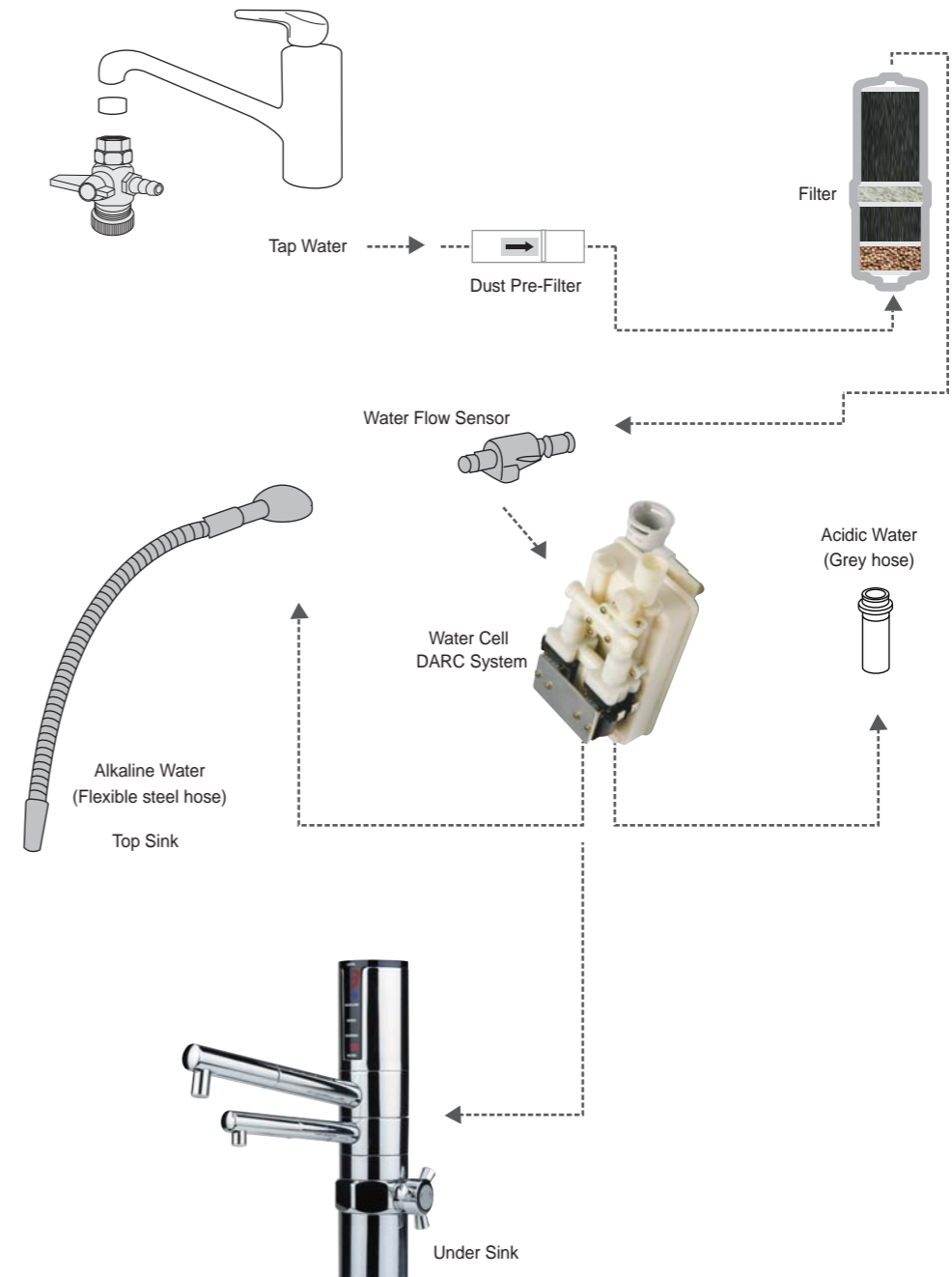

# Trouble Shooting Guide

Abnormal condition	Cause(s)	Resolution
The Function Display Panel does not come on.	A power plug is not properly inserted, or it is inserted into a faulty outlet.  The fuse is blown. The fuse is not inserted properly.	Properly insert power plug into a correctly functioning power outlet  Replace the fuse. A spare fuse is included in your reagent kit. (3A / 250V fuse)
The Function Display Panel / display indicators do not come on even after turning the tap on.	Faulty PCB (Printed Circuit Board)	Immediately unplug the unit and contact your dealer to arrange service.
pH test shows alkaline water color as neutral (7) while acidic water color gets yellow (6). This is normal if initial pH is 6.5	Faulty or evaporated reagent: alkaline / acidity are always produced in inverse proportion. Therefore, showing an acidic color means inversely that alkaline water has to be generated from the unit. Lack of alkaline color can result from a chemical reaction where carbonic acid in water evaporates some test reagent elements.	Test pH value on level 3 or 4 water; replace reagent.
Power supply is suddenly cut off while operating the unit.	Elevated level of salt in the water or high TDS; extended operation at high pH; sudden flux in electrical current. In these cases your machine will shut down automatically to protect the electrodes and circuitry.	Wait - the unit will become operational again after about one hour. Your ionizer has a safety mechanism built-in to protect the electrodes and circuitry. This mechanism will shut the ionizer down automatically. This mechanism protects the unit from overuse or excessive electric current.
Low output of alkaline water from the unit.	Filter is clogged. Premature clogging may be caused by sudden drop in water quality and an influx of sediment or other contaminants, which stress the filter.  Low pressure in your household plumbing.  The input hose is bent, kinked or otherwise restricted.	Replace your filter.  Clean Pre-filter  Ensure water supply valves are fully open. The water pressure in house may be too low.  Straighten the bent hose.

Abnormal condition	Cause(s)	Resolution
Strange smell from Alkaline water.	Expired filter from ordinary use or premature clogging due to flux in water quality.  Sudden flux in water quality with elevated level of Choline (not Chlorine). Elevated Choline levels are observed in some areas during summer months. These levels fall within safe drinking water standards, yet will cause a reaction with ionized water causing a unique smell.	Replace your filter.  Select lower pH level (1-2). If still present, filter replacement may be necessary.
Water appears milkish; white snow like particles in the bottom of your glass.	You have high hardness (calcium primarily) in your water. The white is extracted CaCO <sub>3</sub> (Calcium carbonate). After CO <sub>2</sub> in water is bonded with Ca where elevated levels of CO <sub>3</sub> exist in your water. In water where elevated levels of CO <sub>3</sub> exist, what you see after ionization is CO <sub>2</sub> in the water bonded with Ca.	This is calcium! It is not only harmless, but actually good for you. Remember the ionizer separates and condenses the alkaline minerals and this is what you are seeing. You can lower the setting (1-2) and reduce this effect. Typically this only occurs in hard water areas.
At first no smell, but then smell from the alkaline water about one hour after.	Your water bottle or receptacle is foul and needs cleaning. Contamination mixes with alkaline water when filling your bottle. Expired filter.	Clean your bottle or receptacle. Try selecting lower pH level (1-2). Replace your filter.
Water leakage from the filter cartridge housing.	Filter not installed correctly into filter housing.	Remove your filter and reinstall it properly following the filter replacement instructions. Increase the quantity of source water inflow.
No acid water flow from the acidic output port.	Acidic output hose is bent, kinked or otherwise restricted.	Straighten the bent hose; increase water flow from supply.



Product Specifications		
Product Manufacture Permission Number	No. 610 by KFDA	
Feature	Ion Water Generator	
Model	IO-400U	
Input Voltage	AC120V / 220V / 240V	
Input Electricity(Power consumption)	0.5A(90W)	
Weight	Approx 6.5kg	
Overall Dimensions	245 X 130X 330(mm)	
Applicable Water inflow Pressure	0.7~5kgf/cm	
Applicable Water Temperature	5~30°C	
Unit Operation Type	One Touch Automatic Ionization Start	
Unit Operation Means	Tap water open and close	
Electrolytic Device	Electrolysis Method	Continuous Electrolysis
	Alkaline Settings	Alkaline 4 Level / Acidic 4 Level
	Ionized Water Output Rate	Max 3 Liters/min (Alkaline+Acidic Water)
	Cleaning Device	Patented DARC(Automatic cleaning)
	Electrode Materials	Platinum and Titanium
Water Purifying Device	Filter Replacement	Easy to replace cartridge
	Filter Life	Activated Carbon Filter : Approx 5~6months (20 liters/day)
	Filter Life Indicator	FND indicator
	Filter Composition	Activated Carbon, Calcium, Biostone, Fiber filter (UF Filter optional)
Temperature shut down	Temperature Sensor / Auto Shut Off	
Water Supply	Direct connection to a tap	

## Memo



**ULTRA DELPHI**  
**ALKALINE ANTIOXIDANT WATER**  
 Experience the Power of Ionized Water from  
 Emco Tech Ionizer NEW ULTRA DELPHI

Memo



**ULTRA DELPHI**

ALKALINE ANTIOXIDANT WATER

Experience the Power of Ionized Water from  
Emco Tech Ionizer NEW ULTRA DELPHI

Memo



**ULTRA DELPHI**

ALKALINE ANTIOXIDANT WATER

Experience the Power of Ionized Water from  
Emco Tech Ionizer NEW ULTRA DELPHI